











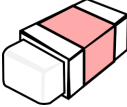

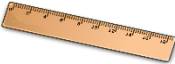

Where's my pen?

مدرسة الرخاء للتعليم الأساسي (4-1)

Small Classroom Objects

				
bag	book	crayon	eraser	pen
				
pencil	pencil case	pencil sharpener	ruler	scissors

Big Classroom Objects

					
chair	computer	cupboard	desk	shelf	table

Main Language

<u>This is</u> my book. <u>These are</u> my books.	<u>Where's</u> the pen? <u>It is</u> in/on/under the desk.	<u>Is</u> it your pencil? Yes, it <u>is</u> .	<u>Can</u> I borrow it, please? Yes. Here <u>you are</u> .
---	---	--	---

1, Look and write full sentences.

bag pen crayon pencil case ruler book

1. This is my book.



Handwriting practice lines (red top and bottom, blue middle) for writing a sentence.



Handwriting practice lines (red top and bottom, blue middle) for writing a sentence.



Handwriting practice lines (red top and bottom, blue middle) for writing a sentence.

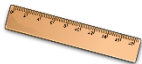

Handwriting practice lines (red top and bottom, blue middle) for writing a sentence.



Handwriting practice lines (red top and bottom, blue middle) for writing a sentence.



1, Look and write full sentences.

pencils scissors pens erasers sharpeners books

These are my books.







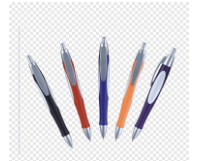

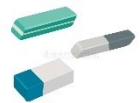



2. Order the words and write the sentences



computer	It	a	.	is
----------	----	---	---	----

This	a	is	chair	.
------	---	----	-------	---





table	.	is	a	It
-------	---	----	---	----





a	This	.	is	cupboard
---	------	---	----	----------



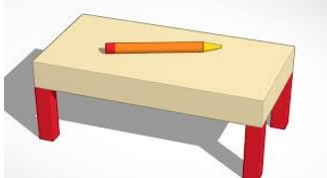

is	It	shelf	a	.
----	----	-------	---	---

3. Read and circle.

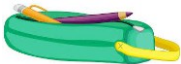
1.	<p>Where is the crayon?</p> <p><u>It is on the table.</u></p> <p>It is under the table.</p>	
2.	<p>Where is the pencil?</p> <p>It is on the table.</p> <p>It is under the table.</p>	
3.	<p>Where is the bag?</p> <p>It is in the chair.</p> <p>It is under the chair.</p>	
4.	<p>Where is the computer?</p> <p>It is on the desk.</p> <p>It is under the desk.</p>	
5.	<p>Where is the pencil?</p> <p>It is on the pencil case.</p> <p>It is in the pencil case.</p>	
6.	<p><u>Draw and write:</u></p>	

Look , read and complete.



on in under

- 1) The books are -----the table.
- 2) The sharpener is ----- the pencil case.
- 3) The scissors are -----the chair.
- 4) The ruler is -----the bag.
- 5) The bag is ----- the table.
- 6) The crayons are-----the table.
- 7) The eraser is-----the pencil case

Write a complete sentence about the picture. You should use the given Words

in on under

The sharpener is on the book.



sharpener
book

1- -----



ruler
bag

2- -----

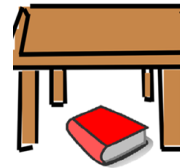

book
table

3- -----



computer
desk

4- -----



book
bag

5- -----



bag
chair

Read , Write and Colour

This is my book. It is
blue. It is on the table.

Colour:

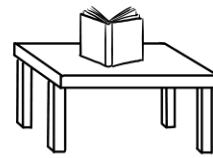

Complete:

----- is ----- pencil. It ---
yellow. ----- is ----- the
pencil case.

Colour:



Write :

Handwriting practice lines consisting of alternating red and black horizontal lines.

Colour:



WRITING 1 (A) (5 marks)

Look at the pictures. Complete the missing letters in each word. There is one example.

Example:



h o u s e

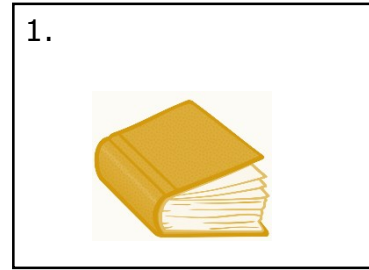

b - - -

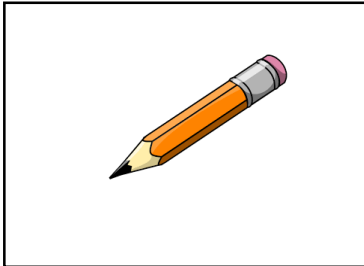

p - - c - -

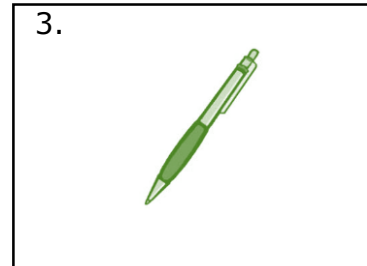

p - -



b - -

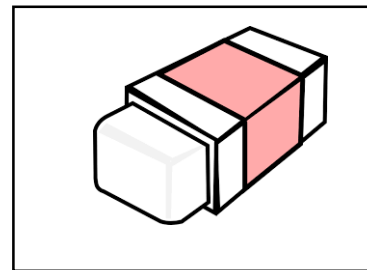

e - a - - -

WRITING 2

(4 marks)

Look at the pictures. Look at the letters. Write the correct word. There is one example.

Example:

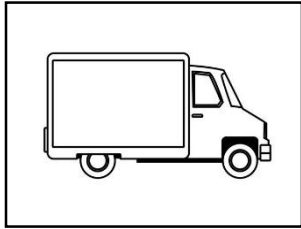

a	n	v
---	---	---

v a n

1.



a	t	e	b	l
---	---	---	---	---

2.

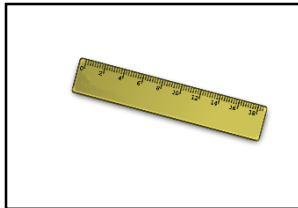

e	r	r	u	l
---	---	---	---	---

3.

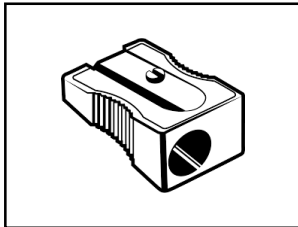

a	r	s	e	h	n	p	r	e
---	---	---	---	---	---	---	---	---

4.

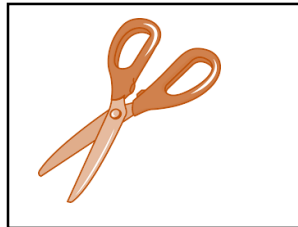

c	s	s	i	s	r	o	s
---	---	---	---	---	---	---	---

**WRITING
SCORE**

4

READING 1 (Items 1-5)

(5 marks)

Look at the pictures. Tick (✓) the correct phrase that best describes the picture. There is one example.

Example:

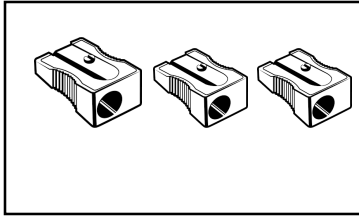

- There are 2 sharpeners.
- There are 3 sharpeners.

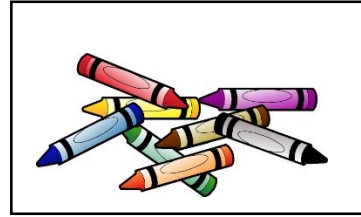

- These are my crayons.
- These are my books.



- It is a cupboard.
- It is a shelf.

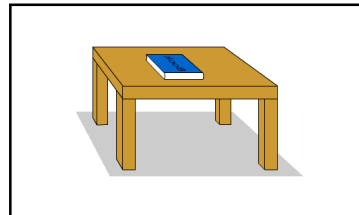

- The book is on the table.
- The book is under the table.



- The ruler is on the bag.
- The ruler is in the bag.



- This is a shelf.
- This is a computer.

Listening Quiz

Name :

Class:

LISTENING 2 (Items 1-5)

(5 marks)

You are going to hear five short sentences. Number the pictures from (1-5) in the box under each picture. There is one example.

A.



B.

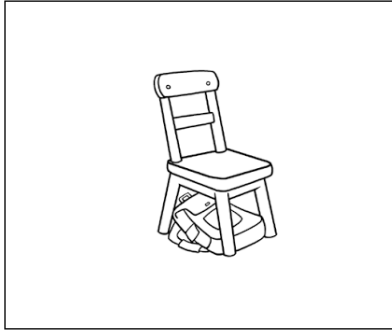

C.

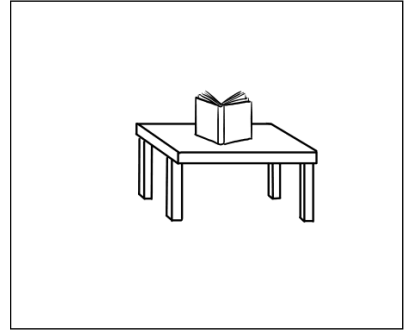

D.

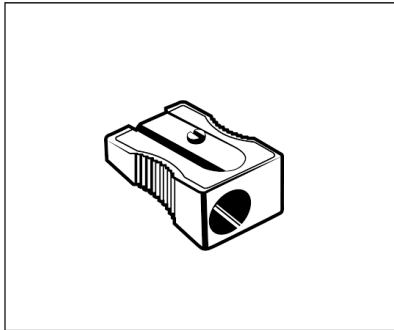

E.

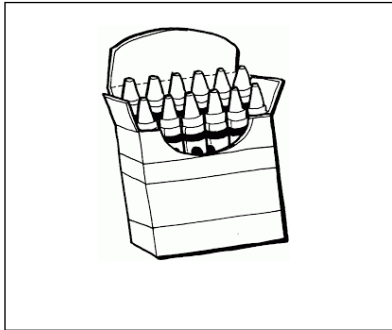

F.

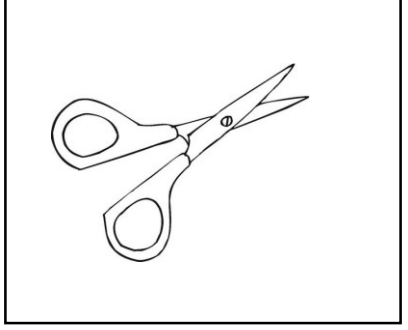





**LISTENING
SCORE**

5

1. Match the number with the Word.

0	Five
1	Eight
2	One
3	Ten
4	Zero
5	Nine
6	Four
7	Two
8	Six
9	Three
10	Seven

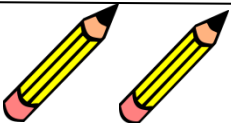
2. Count and write the number.

Example: 	*How many books are there? *There are <u>three</u> books.
	*How many balls are there? *There are _____ balls.
	*How many pencils are there? *There are _____ pencils.
	*How many scissors are there? *There are _____ scissors.



"or"

1. Listen and choose the correct word for each picture.

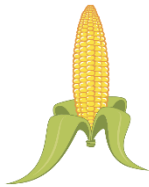

corn
storm



sport
storm



fork
north



torch
fork



north
sport

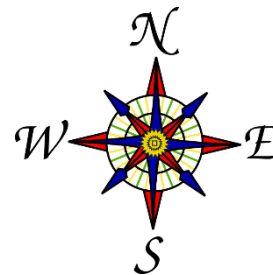

north
torch

2. Find 5 words that have "or" sound.

fork see torch jeep
wait north man paid pain
sport tree again cork

3. Write the correct word for each picture.

1. It is my _____ .



2. This is a _____ .

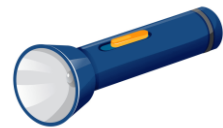

3. I want a _____ .



4. It is a _____ .



Read

our



Build



Trace

our

Write

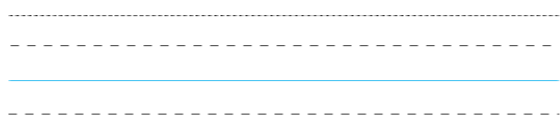

Circle

his our he she our hat his our
hi hen our his

Complete and match

1. It is _____ car.



2. It is _____ book.



3. It is _____ crayon.

1. Read and match.



"ng"



sting



ring



king



sing

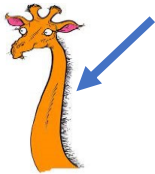

long



swing

2. find 5 words with ng sound

goat

sting

got

lot

toast

load

bang

more

long

book

swing

hat

sing

Read

their

Build

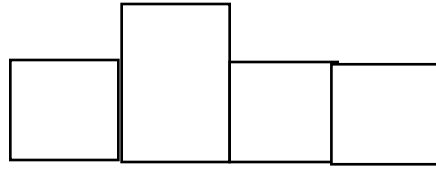

Trace

their

Write

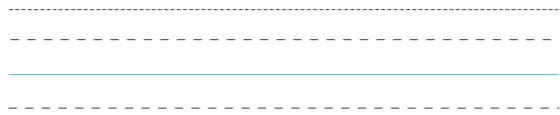

Circle

their her their she his their
his their hi hen their her

Complete and match

1. It is _____ book.

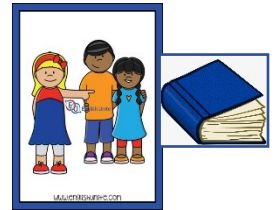

2. It is _____ computer.

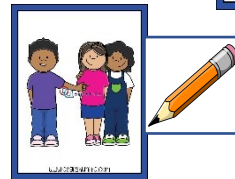

3. It is _____ pencil.

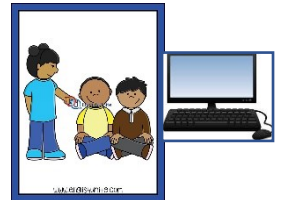



1. Listen and colour the correct word for each picture.



hook
book

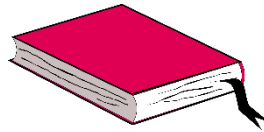

look
book



foot
cook

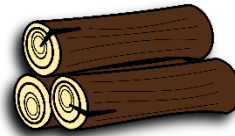

look
wood



book
cook



look
hook

2. find 5 words with oo sound

goat look got lot wood
cook bang more long book
swing hook sing

Read

Why

Build

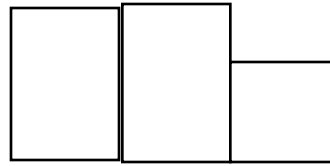

Trace

Why

Write

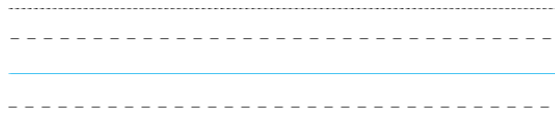

Circle

their why their why his why his
their why hen their why

Complete and match

1. _____ is she sad?

2. _____ is he happy?

3. _____ is he running?





2. Listen and colour the correct word for each picture.



hook
broom



moon
broom



spoon
cook



boot
roof



book
room



tooth
broom

2. find 5 words with oo sound

goat broom got lot moon
spoon bang more long boot
swing roof sing

Read

When

Build

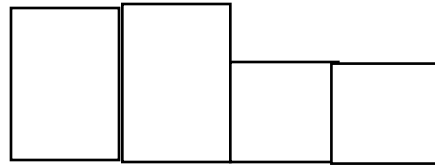

Trace

When

Write

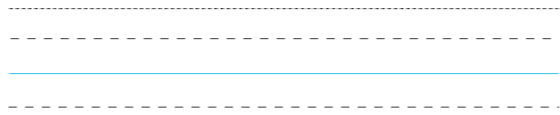

Circle

their when what why when who
his when why when their why

Complete and match

1. _____ is your birthday?



2. _____ do you read a book?



3. _____ does he get up?

